

FIRE BRIGADE.

Secure fire protection doors for any location

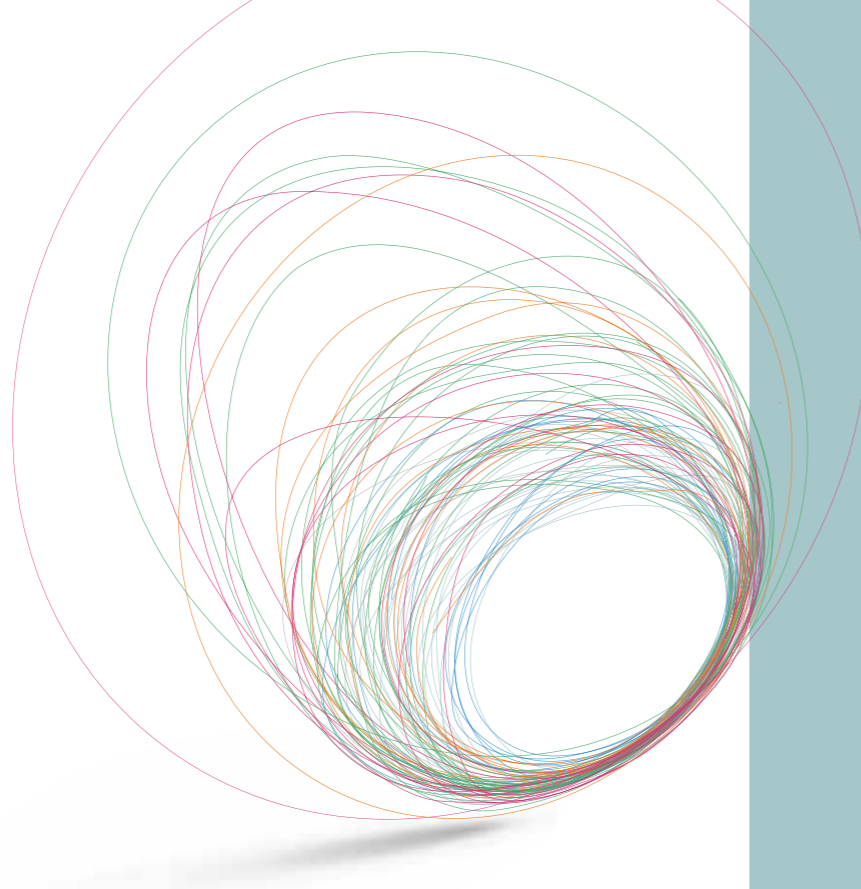



MADE
IN
GERMANY



TECKENTRUP DOOR SOLUTIONS

Performance promise and service standards

Design | Security | Service

Pages 4 - 9

Fire protection doors

T30 sliding door 2.0
T90 sliding doors
T90 lifting door

Page 12 - 15
Page 16 - 17
Page 18 - 19

Design variety

Doors, colours and glazing

Page 20 - 23

Security aspects

Planning tools, technical data

Page 26 - 27

Whether it's development, production or distribution, whether it's about the entire whole or about a small detail, for us, everything revolves around the decisive question: **WHAT IS THE SOLUTION FOR YOU?**

Because we are the specialist for fire protection, smoke protection, sound insulation and security doors, for industrial sectional doors, rolling shutters, folding doors, sliding doors and garage doors.

And we are **"Made in Germany"**. For more than 80 years, we have developed and produced our products exclusively in Germany. More than 900 employees at our locations in Verl and Großzöberitz create our high-quality products for you. All processes, from supply to production to commissioning and delivery, are based on the DIN EN ISO 9001 quality management system.

DESIGN SECURITY SERVICE

Teckentrup produces more than doors and gates: Teckentrup delivers solutions. Which is why we have applied three new standards to our company and our products which meet your needs: Design. Security. Service.

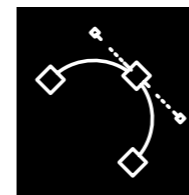

Design: We link functionality and aesthetics.

Because good design represents innovative technology that meets the needs of the user. Our products are opening new worlds and offer many individual design options. With us, designers and engineers work hand-in-hand from the beginning. So that intelligent ideas are just as convincing at the second glance and sophisticated designs prove themselves day after day.



Security: We link systems to protection.

Our doors meet the highest requirements and are certified accordingly. We are happy to advise you on necessary standards and develop comprehensive needs-oriented safety approaches in order to protect people and valuables.



Service: We link speed to reliability.

Proximity, clear structures, everything from one source. This is the service advantage of Teckentrup. Because, from product development to installation, from the committed support of our expert advisers to professional servicing: we will be there for you right away. We are happy to make the time.



BUILDING EXPERTISE FROM ONE SOURCE

Large construction projects are faced with enormous cost pressure. This is why all of our products are embedded in an approach for process optimisation. We count on holistic service – from planning to installation to operating our industrial sectional doors. We can support you with consultation and planning services, we provide just-in-time deliveries if required, we place great emphasis on easy installation and we are also there to help you at any time during the construction phase by providing solutions at short notice. Therefore, you can rest assured that you receive the right solution for all of your property's requirements.

OUR SERVICES FOR YOU

Secure clear efficiency advantages for yourself in every project phase:

- Comprehensive property and project advising for each of your projects
- Digital configurator as first step to your individual door solutions
- Tender documents and technical drawings to develop your tender

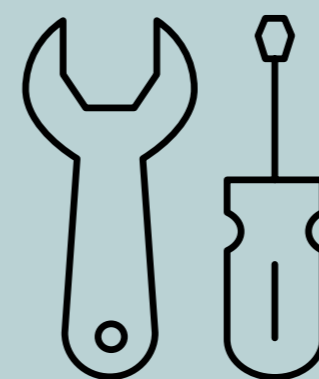

More information at www.teckentrup.biz

HOLISTIC SERVICE

We provide custom solutions and comprehensive service to our customers, from project planning to installation to operating our products. Take a look for yourself.

PASING ARCADEN MUNICH

"Pasing Arcaden" shopping centre in Munich offers three levels and on a total footprint of 39,000 square metres there are 150 shops and 60 exclusive residential units. Apart from aesthetic desires and demands of the building owners, strict fire prevention regulations apply because the centre has been designed to accommodate high levels of visitors whose safety must be guaranteed at all times. At the inauguration alone around 80,000 visitors flocked to Arcaden.

The centre demonstrates how fire protection can be elegantly integrated into the design concept: sophisticated covers hide Teckentrup fire protection doors in the walkways. Technically sophisticated doors with extreme dimensions of 8 metres are required in the underground car park.



T90 sliding doors have been elegantly concealed in a wall slot of the building structure between two retail units. They are not visible as part of normal operation. A rail in the ceiling guarantees reliable movement of the doors. In the event of a fire the niche flaps open automatically so that the doors slide into the corridors to provide a fire barrier for 90 minutes. Niche flaps are opened by an automatic control system and triggered using smoke detectors or a trigger button so the door closes. A notification is also output to the centre's management. Wicket doors without thresholds also keep the escape routes free when the door is closed.



You can find more exciting property reports at www.teckentrup.biz

TECKENTRUP
DOOR SOLUTIONS

ROBUST, SECURE AND PROTECTIVE

Fire protection doors.

Teckentrup has been providing tried and tested fire protection for years. As early as in 1974 Teckentrup was granted approval for the first fire protection sliding door in Germany. Since then the tried and tested as well as permanently enhanced range of fire protection doors features solutions for all eventualities as per the specified building situation or individual demands. First-class materials and precise workmanship guarantee quality, reliability and a long service life. Simple control and reliable door operation are guaranteed thanks to cutting-edge drive and control systems.

T30/T90 sliding doors

Fire protection sliding doors perfectly merge a modern styling, compact design, easy installation and simply operation. Choose between using a wicket door and applying fire-resistant glazing. The fire-proof T90 sliding doors can also be equipped with a wicket door and fire-resistant glazing in the door leaf and/or wicket door upon request.

T90 lifting doors

Teckentrup fire protection lifting doors are safely guided vertically by lateral guiding rails. These models are used anywhere with no space towards the sides or in areas where a fire protection sectional door cannot be used as a result of a high ceiling.

THE NEW GENERATION - SLIDING DOOR 2.0

Our sliding door has never been so easy and quick to install. The installation time has also been reduced by 15% thanks to the reduction in the average surface weight, the individual attachment points and additional parts.

Another plus: less required space from where the door enters to where it is stored.*

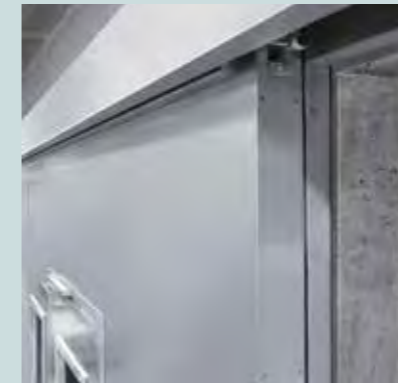

Aesthetics in detail

- Guiding rail/attachments visually tidy and concealed
- End dampers integrated into the door leaf
- Elements separated by appealing concealed groove
- No supporting panel covers

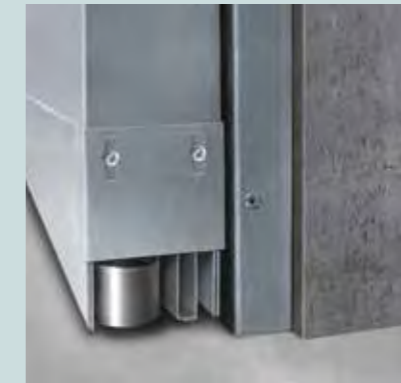

Internal door guide

- Door leaf invisible thanks to internally arranged rollers
- Height-adjustable door guide profile enables compensation by up to 30 mm (e.g. for raised or lowered floors)



Freewheel function

- Very easy to open and close the door without the need for excessive force
- After having opened the door the closing weight is disengaged if the hold-open device has been activated and the door can easily be moved to any position
- When the hold-open device is triggered the door is automatically closed from any position

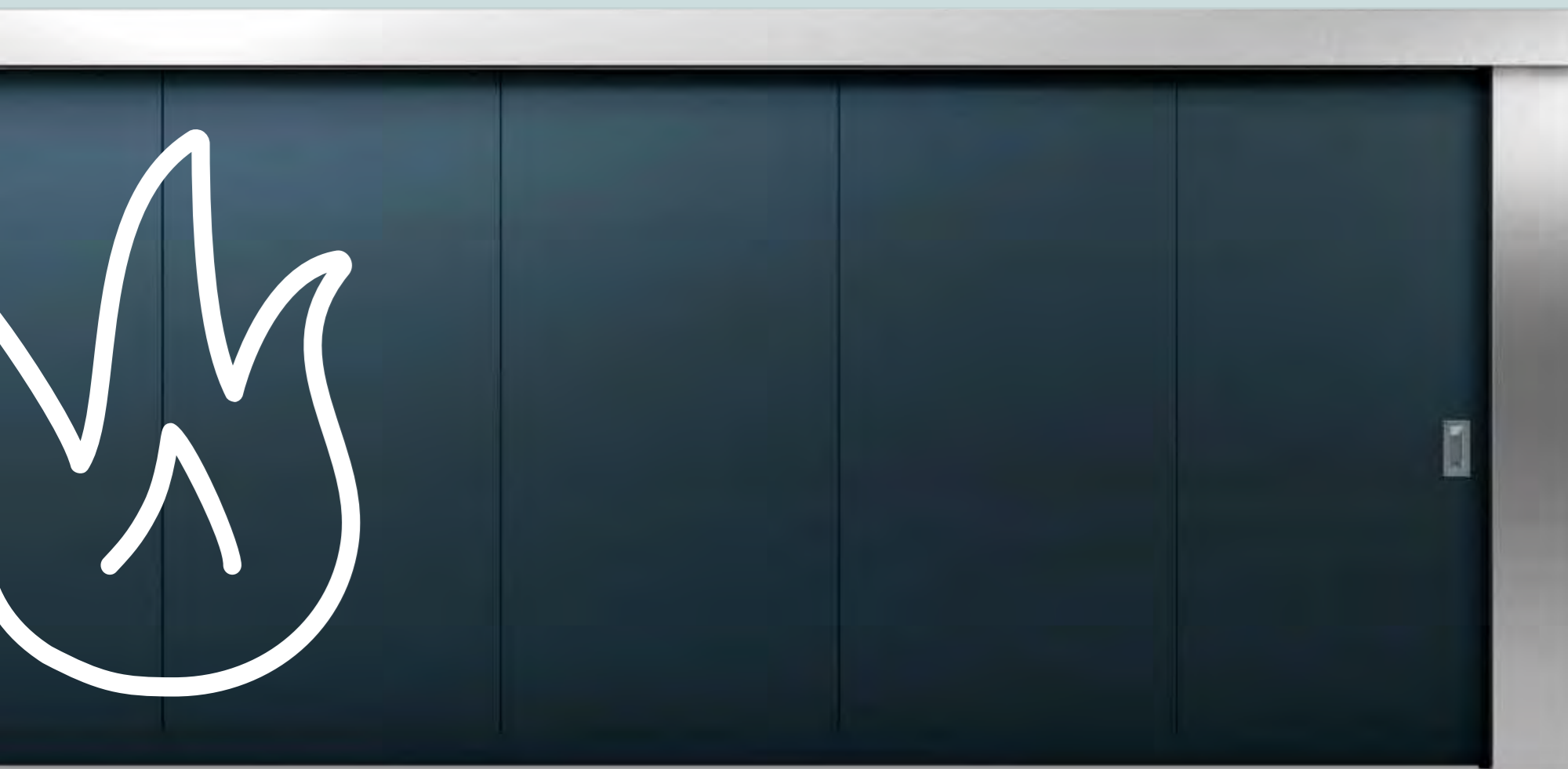

Strong design

- Large range of RAL colours
- Guiding rail arch and guide rail cover available upon request
- With wicket door and glazing



Strong security

- Increased stability of individual elements
- Slopes and inclines where the door opens can be compensated for via the adjustable bottom profile
- Certified fire-resistant and smoke-proof characteristics



Strong service

- Short installation time: Saves up to 15% thanks to lower weight
- Fewer attachments: No guiding rail arch and casing as well as element connection springs
- Care and maintenance: Considerably easier with suspended ceiling or ceiling flaps thanks to omitted trim

*The T30-1-FSA "Teckentrup 72E" 2.0 sliding door requires less space in terms of height (-25 mm), at the counter inlet (-15 mm), in the storage area (-100 mm) and as a result of the weight box in the area where the door enters (-65 mm).



FIRE-RESISTANT STEEL SLIDING DOOR

T30-1-FSA "TECKENTRUP 72 E" 2.0

NEW

- Appealing design
- Quicker installation
- Increased stability

- 1-LEAF
- FOR INDOOR USE
- OPENS TOWARDS THE RIGHT OR LEFT
- OPTIONALLY WITH WICKET DOOR
- OPTIONALLY WITH GLAZING
- ALSO IN STAINLESS STEEL

Installation in

Guiding rail:

- Concrete at minimum 140 mm
- Masonry in storage area only at minimum 175 mm
- Clad F60-A steel beams

Lateral walls:

- Concrete at minimum 140 mm
- Masonry at minimum 175 mm
- Autoclaved aerated concrete walls at minimum 200 mm
For reinforced autoclaved aerated concrete panels at minimum 175 mm
- Clad F60-A steel beams

Surface

Galvanised door leaf and door seal

Special equipment:

- Priming (similar to RAL 9002)
- Stainless steel version
- RAL of your choice

Glazing (optional)

For door leaf and wicket door:
17 mm thick "Promaglas 30" fire protection glass with steel glass retaining strips

Special equipment

- Complete hold-open device consists of: X smoke switches (number of smoke switches corresponds to DIBT directives, edition 1988), one magnetic clamp each, 220/24 V power inverter, trigger button, audible alarm
- Drive asopening aid
- Freewheel function
- Plug-in hook lock-40 + 40 mm profiled cylinder
- Niche flap
- Ceiling flap
- Artificial buffer (1-leaf only)
- Artificial headroom (ceiling installation)
- Trim

Size range/nominal dimensions

Width: 1000 – 8500 mm
Height: 2000 – 6000 mm

Door leaf

Double-walled door leaf consisting of individual elements (number depends on opening width)

- Insulation: Mineral fibre and gypsum board panels
- Door leaf thickness: 72 mm
- Metal sheet thickness: 1.0 mm
- Element weight: approx. 33 kg/m²

1-leaf:

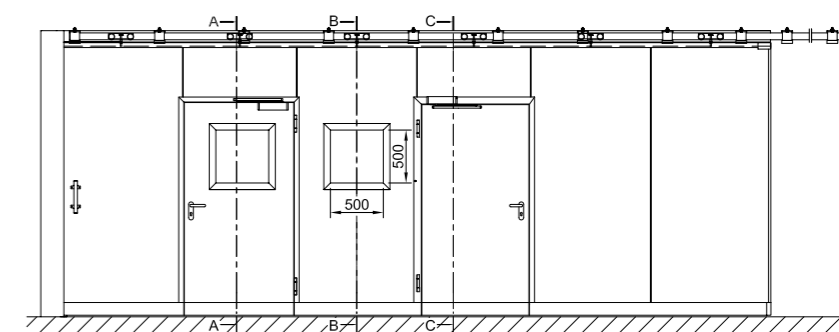

Fire-resistant
As per DIN 4102/EN 1634-1
or European classification
as EI,30 Sa/S₂₀₀-C3



Smoke-proof
As per EN 1634-3/
DIN 18095¹⁾

¹⁾ With supplementary equipment



FIRE-RESISTANT STEEL SLIDING DOOR

T90-1/2-FSA "TECKENTRUP 72 E"

- 1-LEAF AND 2-LEAF
- FOR INDOOR USE
- OPENS TOWARDS THE RIGHT OR LEFT
- OPTIONALLY WITH WICKET DOOR
- OPTIONALLY WITH GLAZING
- ALSO IN STAINLESS STEEL

Installation in

Guiding rail:

- Concrete at minimum 140 mm
- Masonry in storage area only at minimum 175 mm
- Clad F90-A steel beams

Lateral walls:

- Concrete at minimum 140 mm
- Masonry at minimum 175 mm
- Autoclaved aerated concrete walls at minimum 200 mm
For reinforced autoclaved aerated concrete panels at minimum 175 mm
- Clad F90-A steel beams

Size range

Nominal construction dimension, 1-leaf:

Width: 1000 – 8500 mm
Height: 2000 – 6000 mm

Nominal construction dimension, 2-leaf:

Width: 1500 – 8500 mm
Height: 2000 – 6000 mm

Door leaf

- Double-walled individual elements (number depends on opening width)
- Door leaf thickness: 72 mm
- Metal sheet thickness: 1.0 mm
- Insulation: Mineral fibre and gypsum board panels
- Element weight: approx. 44 kg/m²

Surface

Galvanised door leaf and door seal

Special equipment:

- Priming (similar to RAL 9002)
- Stainless steel version
- RAL of your choice

Glazing (optional)

For door leaf and wicket door:
35 mm thick "Promaglas 30" fire protection glass with steel glass retaining strips

Special equipment

- Complete hold-open device consists of: X smoke switches (number of smoke switches corresponds to DIBT directives, edition 1988), one magnetic clamp each, 220/24 V power inverter, trigger button, audible alarm
- Drive asopening aid
- Freewheel function
- Plug-in hook lock-40 + 40 mm profiled cylinder
- Niche flap
- Ceiling flap
- Artificial buffer (1-leaf only)
- Artificial headroom (ceiling installation)

1-leaf:

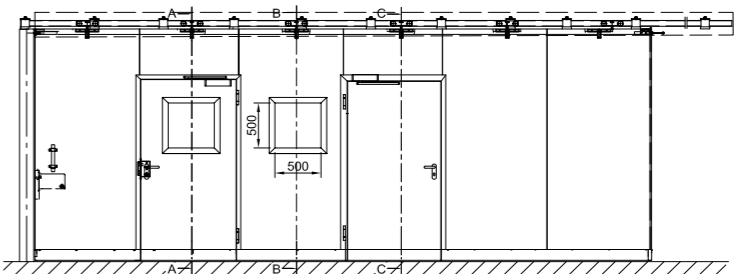

2-leaf:

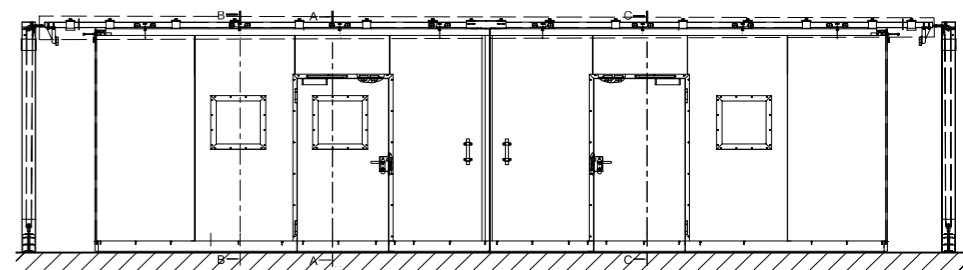

1) With supplementary equipment



Fire-proof
As per DIN 4102/
EN 1634-1



Smoke-proof
As per DIN 18095/
EN 1634-3¹⁾



FIRE-PROOF STEEL LIFTING DOOR

T90-1-FSA "TECKENTRUP HT-E"

- FOR INDOOR USE
- VERTICAL DOOR GUIDE
- WITH ELECTRICALLY POWERED OPENING AID

Installation in

Guiding rail:

- Concrete at minimum 140 mm
- Masonry at minimum 240 mm
- Autoclaved aerated concrete slabs
With reinforced elements at
minimum 175 mm
As per DIN 4165 at minimum
200 mm

Size range

Width: 1000 – 3700 mm
Height: 2000 – 2950 mm

Door leaf

- Double-walled door leaf
- Door leaf thickness: 62 mm
- 1.0 mm metal sheet thickness
- Insulation: mineral fibre and
gypsum board panels
- Reinforcement: U-shaped steel

Surface

Galvanised door leaf and door seal

Fittings

- 2 double pulleys with load-bearing
and safety reserve rope featuring guide
pairs
- 2 damping cylinders
 - 1 radial damper
 - 2 recessed handles

Special equipment

- Complete hold-open device
consists of: X smoke switches
(number of smoke switches corre-
sponds to DIBT directives, edition
1988), 1 magnetic clamp each,
holding brake, 220/24 V power
inverter, trigger button, audible
alarm
- Electrically powered drive as
opening aid in dead man control



Fire-proof
As per DIN 4102/
EN 1634-1



AESTHETIC APPEARANCE

There are no shortcomings in the design either: Our fire protection doors are available with a number of designs and will match the architectural aesthetics of any building.

Choose from numerous design options: whether it's colours, glazing, wicket door or side door, you will find the right solution that fits your requirements here.

Thanks to their appealing styling in contemporary design our fire protection doors are always an eye-catcher.

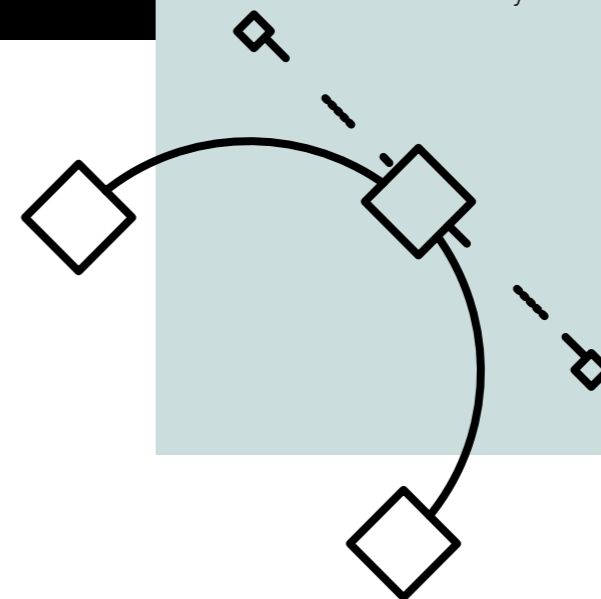



Wicket doors

Wicket doors can also optionally be integrated into the fire protection sliding doors. In this process the smooth, even styling allows perfect integration into the door system. Wicket doors are delivered without threshold as standard.

Additional facts about the wicket door:

- Installation between two door leaf elements
- Double-walled door leaf
- Rebated on 3 sides, no threshold
- Also suitable for escape and emergency routes
- Opens in both directions as required
- Clear structural dimension of door: 1005 x 2009 mm (755 x 1800 mm)
- Insulation: mineral fibre and gypsum board panels
- Metal sheet thickness/door leaf thickness depends on door
- Fitting: 2 units of three-part 3D hinges, mortice lock with knob as per DIN 18250, prepared for pz with special, black lever handle set, sliding rail door closer as per DIN EN 1154
- Special equipment:
 - 45 + 30 mm profiled cylinder
 - Panic lock
 - Optionally two wicket doors
 - Optionally with glazing



Side entrances

Side entrances for persons are common on the sides of the sectional of lifting doors. We offer an ample range of fire protection doors to also meet fire protection requirements in this respect.



Glazing

Benefit from additional light thanks to optional glazing in the sliding or sectional door. We use corresponding fire protection glass for glazing elements. Glazing optionally available in the door leaf as well as sliding door wicket doors.



Colours

Our RAL colour range will optionally give you plenty of design options to visually integrate fire protection doors into existing building architecture.

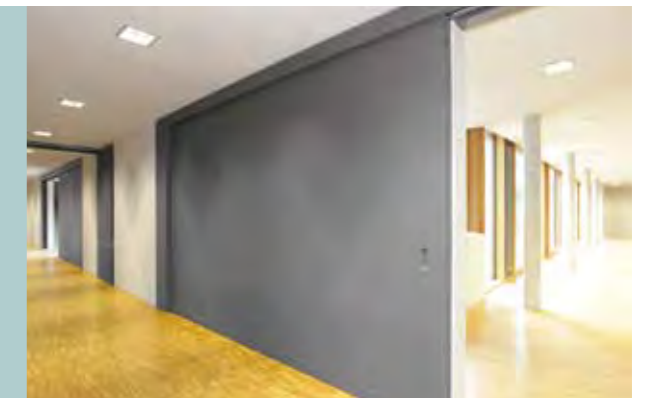

Stainless steel

T30/T90 sliding doors are also available in stainless steel versions and consequently not only meet high design demands, but also requirements in particularly hygienic environments (e.g. in food processing).



GREATEST SECURITY FOR MANY APPLICATIONS

The tried and tested security functions of our fire protection doors meet today's requirements for reliable operation of an integrated system. From the durability of all materials to speed while opening, our doors provide a high degree of security. At Teckentrup, the drive, control system and operating elements form a complete unit that is optimally matched to the corresponding doors and their applications. Solutions for manual drive-operated doors are available depending on the requirements. Teckentrup fire protection doors have been tested as per EN 1634-1 (DIN 4102-5).

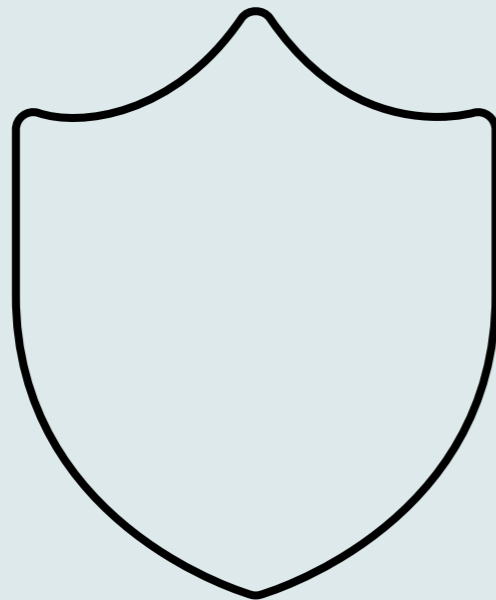

■ = Standard ▲ = Optional

PLANNING SUPPORT FOR ARRANGEMENT OF SMOKE SWITCHES FOR FIRE PROTECTION DOORS

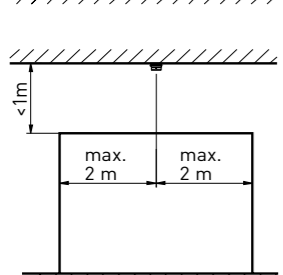
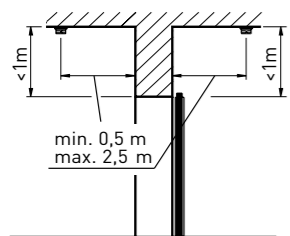

Case 1:
Opening width < 4m and headroom on both sides < 1 m. 2 smoke detectors installed on the ceiling.

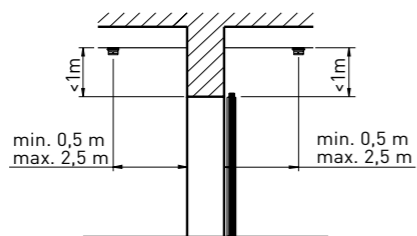

The suspended ceiling has to be classified in terms of fire protection which means that it is tight enough that smoke accumulates under the ceiling.

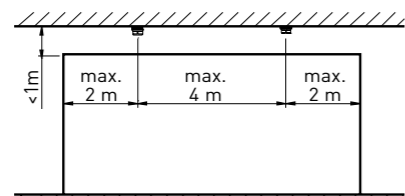

Case 2:
Opening width > 4 m und ≤ 8 m headroom on both sides < 1 m. 4 smoke detectors installed on the ceiling.

For a jointless suspended ceiling classified in terms of fire protection, the headroom has to be chosen up to the lower edge of the suspended ceiling. In case of an open, not in terms of fire protection classified, suspended ceiling, the headroom up to the concrete ceiling is binding.

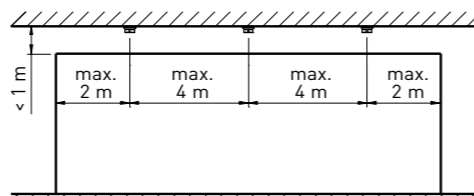

Case 3:
Opening width > 8 m headroom on both sides < 1 m. 6 smoke detectors installed on the ceiling.

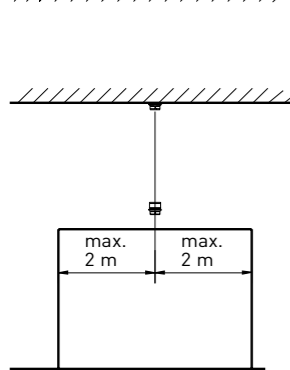
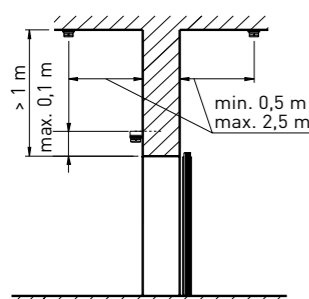

Case 4:
Opening width ≤ 4 m and headroom on one side or on both sides > 1 m. 3 smoke detectors, 2 of them installed on the ceiling, 1 of them installed in front of the headroom.

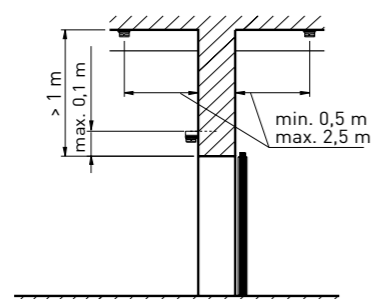

Decorative suspended ceilings are penetrated by smoke. Therefore the smoke detectors have to be installed on the bare ceiling.

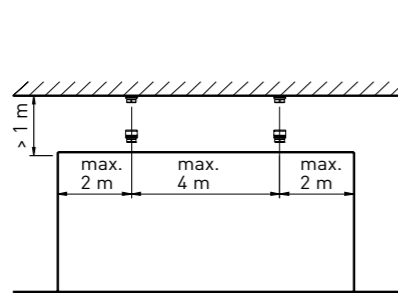

Case 5:
Opening width > 4 m and ≤ 8 m Headroom on one side or on both sides > 1 m. 6 smoke detectors, 4 of them installed on the ceiling and 2 of them installed in front of the headroom.

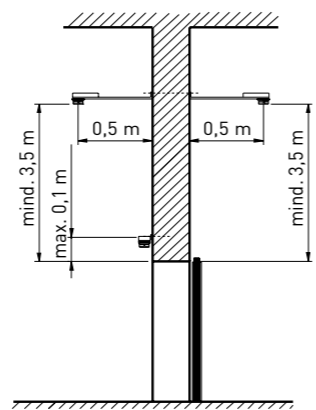

If the distance between the ceiling and the top edge of the wall opening is larger than 5 m, the smoke detectors on the ceiling can be substituted by smoke detectors that are installed 3,5 m above the top edge of the wall opening and on a 0,5 m long console.

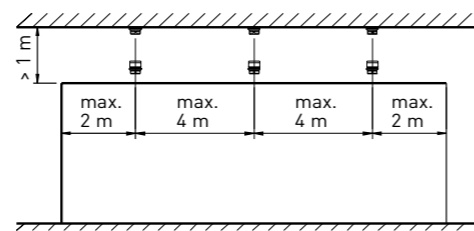

Case 6:
Opening width > 8 m Headroom on one side or on both sides > 1 m. 9 smoke detectors, 6 of them installed on the ceiling and 3 of them installed in front of the headroom.

Main qualification		Fire protection sliding doors		
DOOR DESIGNATION		T30-1-FSA "72"E" 2.0	T90-1-FSA "72"E"	T90-2-FSA "72"E"
Product on pages				
ADDITIONAL QUALIFICATIONS WITH APPROPRIATE EQUIPMENT				
Smoke-proof as per DIN 18095/EN 1634-3		■	■ ¹⁾	■ ¹⁾
DOOR LEAF				
Leaf thickness (mm)		72	72	72
Metal sheet thickness (mm)		1.0	1.0	1.0
Glazing		▲	▲	▲
Opening direction		Opens towards the left or right		
WALL TYPES				
Guiding rail area	Masonry	■	■	■
	Concrete	■	■	■
	Clad steel beams	■	■	■
Lateral walls	Masonry	■	■	■
	Concrete	■	■	■
	Autoclaved aerated concrete slabs	■	■	■
	Reinforced autoclaved aerated concrete panels	■	■	■
	Clad steel beams	■	■	■
SURFACE				
Galvanised		■	■	■
Primed as per RAL 9002 (optional)		▲	▲	▲
RAL of your choice (optional)		▲	▲	▲
Stainless steel (optional)		▲	▲	▲
WICKET DOOR				
Wicket door (optional)		▲	▲	▲
NOMINAL DIMENSION (MM)				
Width	At minimum	1000	1000	1500
	At maximum	8500	8500	8500
	At maximum (with smoke protection)	7000	7000	7000
Height	At minimum	2000	2000	2000
	At maximum	6000	6000	6000
	At maximum (with smoke protection)	4500	4500	4500

¹⁾ Not for stainless steel version

Main qualification		Fire protection lifting door
DOOR DESIGNATION		T30-1-FSA "HT-E"
Product on pages		
DOOR LEAF		
Leaf thickness (mm)		62
Metal sheet thickness (mm)		1.0
Glazing		-
Opening direction		Opens towards the top
INSTALLATION IN		
Walls made of	Masonry	■
	Concrete	■
	Autoclaved aerated concrete as per DIN 4165	■
	For reinforced	■
SURFACE		
Galvanised		■
Primed (RAL 9002)		-
RAL of your choice		-
Stainless steel		-
WICKET DOOR		
Wicket door		-
NOMINAL DIMENSION (MM)		
Width	At minimum	1000
	At maximum	3700
Height	At minimum	2000
	At maximum	2950



DESIGN | SECURITY | SERVICE

Professional solutions

We provide customised solutions for your individual requirements. With our fire protection doors, you can count on more design, security and service.

WWW.TECKENTRUP.BIZ

We are happy to help.